

BIOHORIZONS

# tapered HD surgical system



**BIOHORIZONS**<sup>®</sup>  
SCIENCE • INNOVATION • SERVICE

## tapered implant family



The Tapered Internal family of dental implants provide excellent primary stability, maximum bone maintenance and soft tissue attachment for predictable results. All implants can be placed with the same instrument kit giving you surgical convenience and flexibility to choose the ideal implants for each patient's needs.\*



### restorative ease

45° conical internal hex connection is color-coded for quick identification and component matching

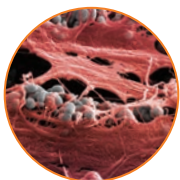

### connective tissue attachment

uniquely creates a physical connective tissue attachment

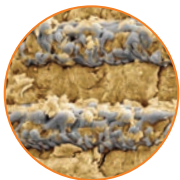

### bone attachment

Laser-Lok® microchannels retain crestal bone



### optimized threadform

buttress thread engineered for superior stability over microthreaded implants

### universal surgical kit

intuitive color-coded instrumentation used to place all BioHorizons Tapered implants\*



\* Tapered Pro, Tapered Plus, Tapered 3.0, Tapered Tissue Level and Tapered Internal

## table of contents

tapered plus implants	2-3
tapered internal implants	4-5
tapered tissue level implants	6
tapered HD surgical kit	7
individual components	8-10
ancillary instruments	11-13
healing abutments and cover caps	14-15
temporary abutments	16
surgical manual introduction	17
surgical protocols	18
implant placement level & spacing	19
surgical kit & drill sequence	20
drill overview	21
osteotomy initialization	22
osteotomy modification	23
final bone preparation & drivers	24
implant transfer	25
healing protocols	26
appendix	27
icon legend	28
ordering, warranty information and references	29

# tapered plus

## platform switching

designed to increase soft tissue volume

## Laser-Lok® zone

creates a connective tissue seal and retains crestal bone

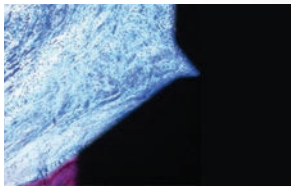

## optimized threadform

buttress thread engineered for superior stability over microthreaded implants

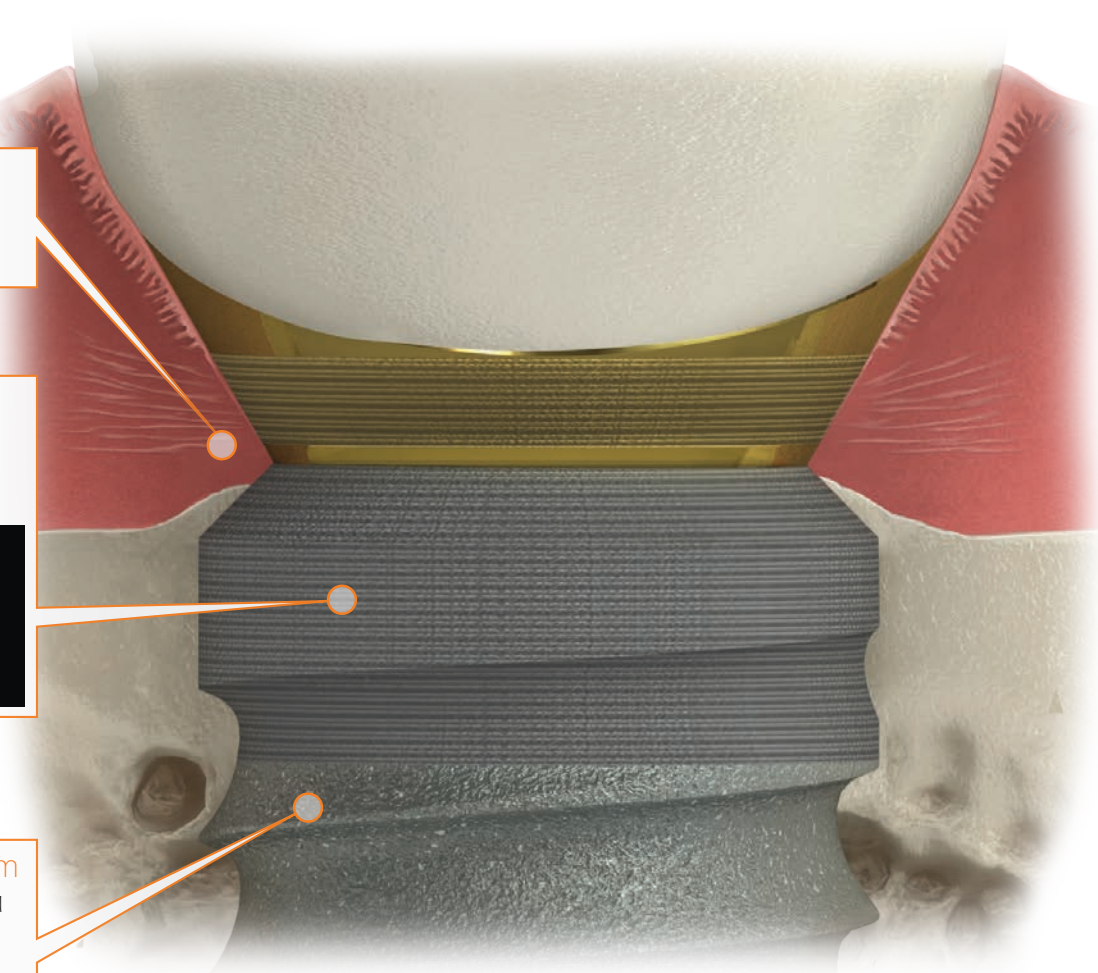

## restorative choices

comprehensive line of internally hexed prosthetics for a wide variety of site conditions and restorative protocols





# product information & ordering

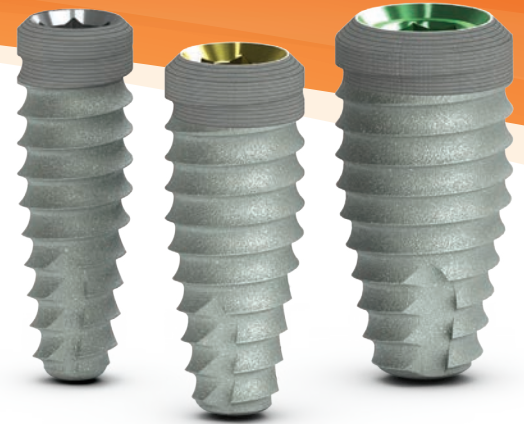

BioHorizons Tapered Plus implants incorporate the highly successful design features of the tapered implant line, offering excellent primary stability, surgical simplicity and tactile feedback. The platform switched Laser-Lok collar provides excellent bone maintenance and soft tissue volume, ideal for esthetically demanding cases.



## features:

- dual affinity Laser-Lok surface creates a connective tissue attachment, retaining crestal bone
- excellent primary stability from anatomically tapered body
- compressive bone loading from proprietary buttress threads
- conical internal hex connection provides a rigid connection and stable biological seal

## Tapered Plus Implants

			
body diameter	3.8mm	4.6mm	5.8mm
prosthetic connection	 3.0mm	 3.5mm	 4.5mm
Laser-Lok zone	1.8mm	1.8mm	1.8mm
apical diameter	2.8mm	3.1mm	3.9mm
platform switch	0.4mm	0.5mm	0.6mm
7.5mm length	—	<b>TLXP4607</b>	<b>TLXP5807</b>
9.0mm length	<b>TLXP3809</b>	<b>TLXP4609</b>	<b>TLXP5809</b>
10.5mm length	<b>TLXP3810</b>	<b>TLXP4610</b>	<b>TLXP5810</b>
12.0mm length	<b>TLXP3812</b>	<b>TLXP4612</b>	<b>TLXP5812</b>
15.0mm length	<b>TLXP3815</b>	<b>TLXP4615</b>	<b>TLXP5815</b>

Laser-Lok collar with Resorbable Blast Texturing (RBT) on implant body. Mount-free for quick placement and maximum site visibility. Comes packaged with a Cover Cap. Titanium Alloy (Ti-6Al-4V ELI).

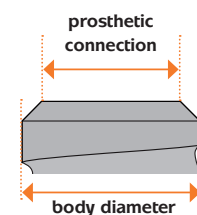
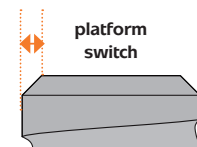
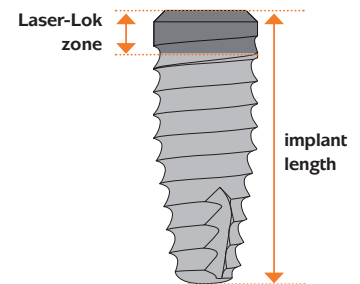



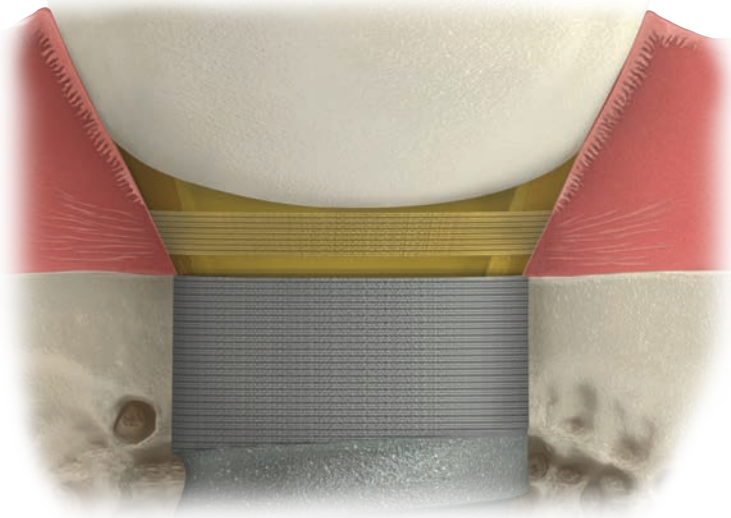





# tapered internal

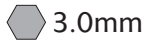
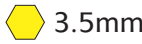
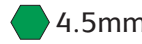

BioHorizons flagship Tapered Internal implants are now available in 5 diameters and 6 lengths. The dual affinity Laser-Lok surface offers flexible implant placement, providing excellent bone maintenance and a stable soft tissue seal. Proprietary buttress threads and an anatomically tapered body provide compressive loading and excellent primary stability.

## Mount-free Tapered Internal Implants

					
body diameter	3.0mm	3.4mm	3.8mm	4.6mm	5.8mm
prosthetic connection	 3.0mm	 3.0mm	 3.5mm	 4.5mm	 5.7mm
Laser-Lok zone	2.1mm	1.8mm	1.8mm	1.8mm	1.8mm
apical diameter	2.0mm	2.4mm	2.8mm	3.1mm	3.9mm
7.5mm length	—	—	—	<b>TLX4607</b>	<b>TLX5807</b>
9.0mm length	—	<b>TLX3409</b>	<b>TLX3809</b>	<b>TLX4609</b>	<b>TLX5809</b>
10.5mm length	<b>TLX3010</b>	<b>TLX3410</b>	<b>TLX3810</b>	<b>TLX4610</b>	<b>TLX5810</b>
12.0mm length	<b>TLX3012</b>	<b>TLX3412</b>	<b>TLX3812</b>	<b>TLX4612</b>	<b>TLX5812</b>
15.0mm length	<b>TLX3015</b>	<b>TLX3415</b>	<b>TLX3815</b>	<b>TLX4615</b>	<b>TLX5815</b>
18.0mm length	—	<b>TLX3418</b>	<b>TLX3818</b>	<b>TLX4618</b>	—

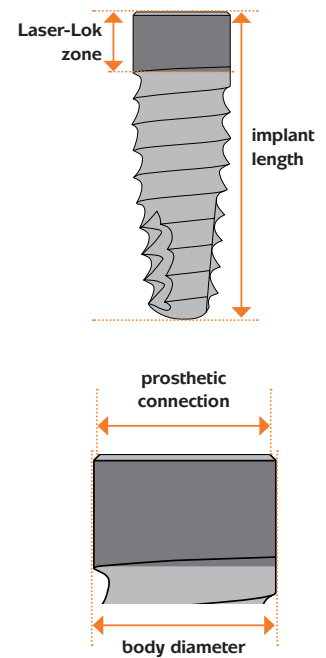

Expanded Laser-Lok zone with no smooth, machined area. Resorbable Blast Texturing (RBT) on implant body. Packaged mount-free for quick placement and maximum site visibility. Comes packaged with a Cover Cap. Titanium Alloy (Ti-6Al-4V ELI).

# product information & ordering

## Tapered Internal Implants with 3inOne Abutment

			
body diameter	3.8mm	4.6mm	5.8mm
prosthetic connection	 3.5mm	 4.5mm	 5.7mm
Laser-Lok zone	1.5mm	1.5mm	1.5mm
apical diameter	2.8mm	3.1mm	3.9mm
7.5mm length	—	<b>TLR4607</b>	<b>TLR5807</b>
9.0mm length	<b>TLR3809</b>	<b>TLR4609</b>	<b>TLR5809</b>
10.5mm length	<b>TLR3810</b>	<b>TLR4610</b>	<b>TLR5810</b>
12.0mm length	<b>TLR3812</b>	<b>TLR4612</b>	<b>TLR5812</b>
15.0mm length	<b>TLR3815</b>	<b>TLR4615</b>	<b>TLR5815</b>

Laser-Lok collar with Resorbable Blast Texturing (RBT) on implant body. Comes packaged with a Cover Cap, Abutment Screw and pre-mounted 3inOne esthetic abutment that serves as a fixture mount, closed-tray transfer coping (when used with a ball-top screw) and final abutment. Titanium Alloy (Ti-6Al-4V ELI).

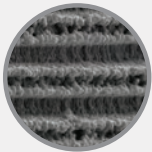

## Laser-Lok<sup>®</sup> microchannels better science, better implants

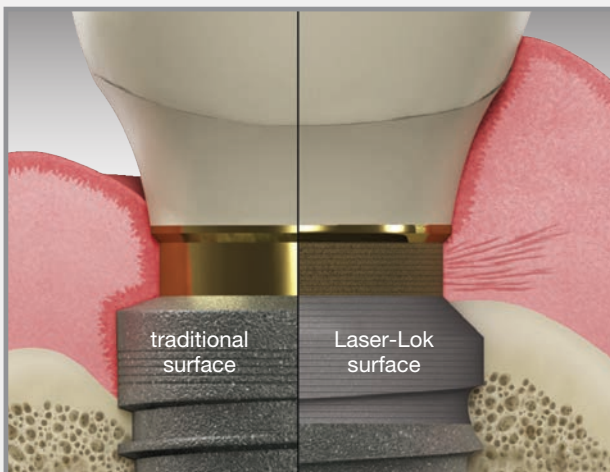

- over 25 years of *in vitro*, animal and human studies at leading universities<sup>1</sup>
- reduced incidence of peri-implantitis compared to traditional surfaces<sup>2</sup>
- only surface shown to attract a physical, connective tissue attachment<sup>3-11</sup>
- overdenture study showing only 0.42mm of bone loss compared to 1.13mm for NobelReplace™ Select<sup>12</sup>

learn more at  
[www.laser-lok.com](http://www.laser-lok.com)

# tapered tissue level

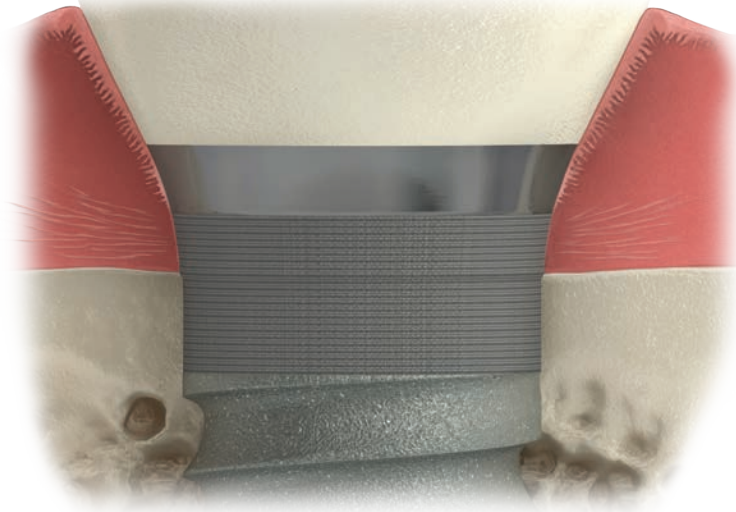

Tapered Tissue Level implants feature a trans mucosal collar for one stage procedures and Laser-Lok surface technology to inhibit epithelial downgrowth, attach connective tissue and create a biologic seal around the implant. Tapered Tissue Level implants are available in 4 diameters including the only two-piece 3mm tissue level implants currently available for tight spaces.<sup>†</sup>

## Tapered Tissue Level Implants

body diameter	3.0mm	3.8mm	4.6mm	5.8mm
prosthetic connection	3.5mm	3.5mm	4.5mm	5.7mm
Laser-Lok zone	2.0mm	2.0mm	2.0mm	2.0mm
apical diameter	2.0mm	2.8mm	3.1mm	3.9mm
collar height	2.3mm	2.3mm	2.3mm	2.3mm
bevel height	0.5mm	0.5mm	0.5mm	0.5mm
max collar width	4.5mm	4.5mm	5.5mm	6.7mm
7.5mm length	—	<b>TTLY3807</b>	<b>TTLG4607</b>	<b>TTLB5807</b>
9.0mm length	—	<b>TTLY3809</b>	<b>TTLG4609</b>	<b>TTLB5809</b>
10.5mm length	<b>TTLY3010</b>	<b>TTLY3810</b>	<b>TTLG4610</b>	<b>TTLB5810</b>
12.0mm length	<b>TTLY3012</b>	<b>TTLY3812</b>	<b>TTLG4612</b>	<b>TTLB5812</b>

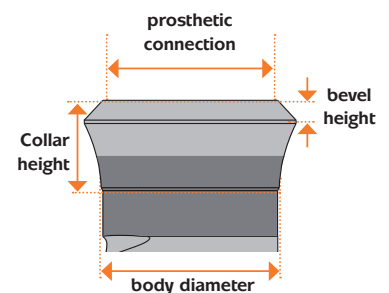
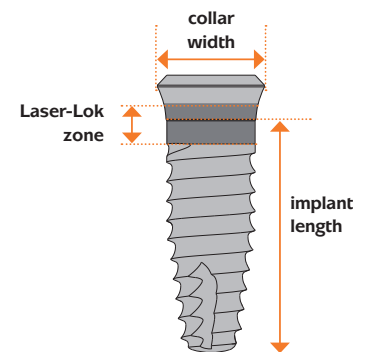

Laser-Lok collar with Resorbable Blast Texturing (RBT) on implant body.  
 Packaged mount-free for quick placement and maximum site visibility.  
 Comes packaged with a Cover Cap. Titanium Alloy (Ti-6Al-4V ELI).

<sup>†</sup> Based on research of competitive data. Thread major is 3.0mm.  
 shop online at [store.biohorizons.com](http://store.biohorizons.com)



## Tapered HD Surgical Kit

### TSK4000

#### Tapered HD Surgical Kit

Includes the instrumentation required to place:  
Tapered Pro, Tapered Plus, Tapered 3.0, Tapered Tissue Level  
and Tapered Internal implants.

### TSK3500

#### Tapered HD Surgical Kit (without instruments)

#### features:

- versatile, removable, hinged lid
- 40% smaller and 40% lighter than other kits
- easy to disassemble and assemble during cleaning
- implant staging area for implant vials during surgery
- use to place Tapered Pro, Tapered Internal, Plus, 3.0 and Tissue Level
- empty spare slots for other instrumentation such as stop drills or extended shank drills

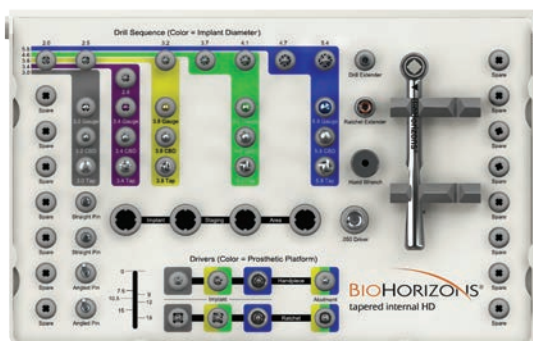

The surgical kit features an intuitive color-coded layout that guides the surgeon through the instrument sequence. The drilling section is color-coded by implant diameter. The implant driver section is color-coded by prosthetic connection.

# INDIVIDUAL COMPONENTS

## HD Drills

The Tapered HD drills feature highly efficient cutting flutes for crisp osteotomies in even the densest bone. Simplified drill markings correspond to the six Tapered Internal family implant lengths. Drills should be replaced every 12-20 osteotomies for maximum cutting efficiency.

### features:

- cutting flutes designed for maximum efficiency
- non-reflective surface for high visibility
- simplified drill markings match each implant length
- compatible with Tapered Pro, Tapered Internal, Plus, 3.0 and Tissue Level
- creates 12-20 osteotomies depending on bone density
- recommended drill speed 1,500-2,000 rpm (2.0 & 2.5mm), 1,000 rpm (all others)

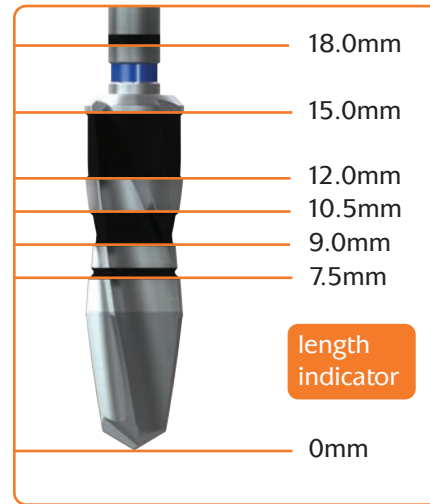

<b>TSD2020HD</b>	2.0mm HD Drill
<b>TSD2025HD</b>	2.5mm HD Drill
<b>TSD2028HD</b>	2.8mm HD Drill
<b>TSD2032HD</b>	3.2mm HD Drill
<b>TSD2037HD</b>	3.7mm HD Drill
<b>TSD2041HD</b>	4.1mm HD Drill
<b>TSD2047HD</b>	4.7mm HD Drill
<b>TSD2054HD</b>	5.4mm HD Drill

# INDIVIDUAL COMPONENTS

## Other HD Instruments



<b>TDG2030HD</b>	3.0mm HD Depth Gauge
<b>TDG2034HD</b>	3.4mm HD Depth Gauge
<b>TDG2038HD</b>	3.8mm HD Depth Gauge
<b>TDG2046HD</b>	4.6mm HD Depth Gauge
<b>TDG2058HD</b>	5.8mm HD Depth Gauge



<b>TSC2030HD</b>	3.0mm HD Crestal Bone Drill
<b>TSC2034HD</b>	3.4mm HD Crestal Bone Drill
<b>TSC2038HD</b>	3.8mm HD Crestal Bone Drill
<b>TSC2046HD</b>	4.6mm HD Crestal Bone Drill
<b>TSC2058HD</b>	5.8mm HD Crestal Bone Drill



<b>TST2030HD</b>	3.0mm HD Bone Tap
<b>TST2034HD</b>	3.4mm HD Bone Tap
<b>TST2038HD</b>	3.8mm HD Bone Tap
<b>TST2046HD</b>	4.6mm HD Bone Tap
<b>TST2058HD</b>	5.8mm HD Bone Tap

### Color coding of HD Instruments

Drills, taps and depth gauges are color-coded by implant body diameter:

- 3.0mm body - no color indicator
- 3.4mm body - purple
- 3.8mm body - yellow
- 4.6mm body - green
- 5.8mm body - blue

# INDIVIDUAL COMPONENTS

## Miscellaneous Instruments



- TP3IDRL** 3.0 Implant-level Driver, Handpiece, Long (sold separately)
- TP3IDHR** 3.0 Implant-level Driver, Handpiece, Regular
- TP3IDRR** 3.0 Implant-level Driver, Ratchet, Regular



- TYGIDH** 3.5/4.5mm HD Implant-level Driver, Handpiece
- TYGIDR** 3.5/4.5mm HD Implant-level Driver, Ratchet



- TBIDH** 5.7mm HD Implant-level Driver, Handpiece
- TBIDR** 5.7mm HD Implant-level Driver, Ratchet



- PHA** Abutment-level Driver, Handpiece\*
- PRA** Abutment-level Driver, Ratchet

### Color coding of Drivers

Drivers are color-coded by prosthetic connection:

- 3.0mm platform - no color indicator
- 3.5mm platform - yellow
- 4.5mm platform - green
- 5.7mm platform - blue



**130-000**  
Ratchet



**300-205**  
4mm Square Drive Extender



**300-400**  
Hand Wrench



**135-351**  
.050" (1.25mm)  
Hex Driver



**122-100**  
Drill Extender



**144-100**  
Straight  
Parallel Pins  
(2 per kit)



**144-200**  
20° Angled  
Parallel Pins  
(2 per kit)



**144-230**  
30° Angled  
Parallel Pins  
(sold separately)

\* An alternate abutment-level driver (PADHH) is available for W&H handpieces that feature the hexagon chucking system.



# ANCILLARY INSTRUMENTS

## 2.5mm Tapered Depth Drills with Stops



- TSD202507HD** 2.5mm Tapered Depth Drill, 7.5mm Stop
- TSD202509HD** 2.5mm Tapered Depth Drill, 9mm Stop
- TSD202510HD** 2.5mm Tapered Depth Drill, 10.5mm Stop
- TSD202512HD** 2.5mm Tapered Depth Drill, 12mm Stop
- TSD202515HD** 2.5mm Tapered Depth Drill, 15mm Stop

Stops are set to same length as each implant for crestal placement.

## Extended Shank HD Drills



- TSD4020HD** 2.0mm Extended Shank HD Drill
- TSD4025HD** 2.5mm Extended Shank HD Drill
- TSD4028HD** 2.8mm Extended Shank HD Drill
- TSD4032HD** 3.2mm Extended Shank HD Drill
- TSD4037HD** 3.7mm Extended Shank HD Drill
- TSD4041HD** 4.1mm Extended Shank HD Drill
- TSD4047HD** 4.7mm Extended Shank HD Drill
- TSD4054HD** 5.4mm Extended Shank HD Drill

Extended Shank Drills are 8mm longer than our standard drills.

## Burs



- 122-015** 1.5mm starter drill

The 1.5mm starter drill facilitates precise initiation of osteotomies and features a 10.5mm depth marking.

- 122-110** 2.0mm Lindemann Bone Cutter

Side-cutting drill used to correct eccentric osteotomy preparations.

- 122-104** Alignment Drill

The alignment drill can be used to initiate the osteotomy to a depth of 5mm. The cutting surface of the drill hub prepares the crestal bone for the depth drill.

- 122-106** #6 Round Bur

## Bone Profiling Burs



- TP3DBP** 3.0mm Bone Profiling Bur & Guide
- PYDBP** 3.5mm Bone Profiling Bur & Guide
- PGDBP** 4.5mm Bone Profiling Bur & Guide
- PBDBP** 5.7mm Bone Profiling Bur & Guide

Use at implant uncover to remove excess crestal bone for proper abutment seating. Screw the guide into the implant and align the profiling bur for precise bone removal. Match profiler & guide color to prosthetic connection.

# ANCILLARY INSTRUMENTS

## Tissue Punches



- 122-200** 3.0mm Tissue Punch (for a 3.3mm incision)
- PYTP** 3.5mm Tissue Punch (for a 3.9mm incision)
- PGTP** 4.5mm Tissue Punch (for a 4.7mm incision)
- PBTP** 5.7mm Tissue Punch (for a 6.1mm incision)

Use in flapless surgical procedures to remove a minimal amount of the soft tissue from the crest of the ridge prior to osteotomy preparation or during implant uncover.

## Handpiece Hex Drivers

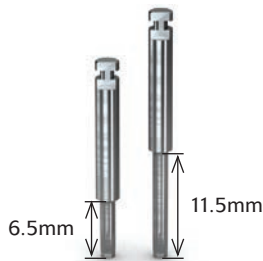

- 134-350** .050" (1.25mm) Handpiece Hex Driver
- 134-450** .050" (1.25mm) Handpiece Hex Driver, Long

For installation and removal of cover screws, healing abutments and abutment screws. The handpiece hex drivers are used with latch-type contra-angle handpieces. The Handpiece Hex Driver, Long (134-450) is 5mm longer than the standard version (134-350).

## Adjustable Torque Wrenches



**C12374** Elos Adjustable Torque Wrench

Lightweight titanium design is easy to use as an adjustable torque wrench with visual indicators for 15, 30, 40, 50, 60, 70, 80 and 90 Ncm. Comes packaged with a 4mm square adaptor. Quickly disassembles for cleaning. No calibration required.



**ATW** ITL Precise Adjustable Torque Wrench

Place both implants and abutments with 9 distinct torque settings (15, 20, 25, 30, 35, 40, 45, 50 and 60 Ncm). A simple twist of the handle locks in precision-engineered torque values and guarantees accuracy and repeatability. Fits any 4mm square component.

**C8521** Elos Replacement Bit, 4mm Square Adaptor

**C8381** Elos Replacement Bit, Handpiece

## Surgical Driver



**150-000** Surgical Driver

Use to drive implants into the osteotomy, particularly in the anterior region. Holds the 4mm Square implant-level drivers and the bone taps.

## Implant Spacer / Depth Probe

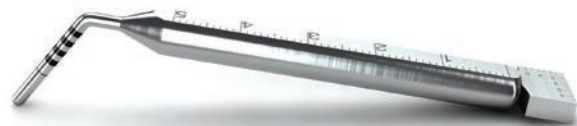

**144-300** Implant Spacer / Depth Probe

Use to provide intraoral measurements. Multi-functional tool for marking implant spacing on the ridge and probing osteotomy depth.

# ANCILLARY INSTRUMENTS

## Guided Surgery Kit

### CGS4000

**Guided Surgery Kit (with instruments)**  
Includes the instrumentation required to place BioHorizons Tapered implants\*

#### Important Note about Guided Surgery Kit

Surgical protocol & guide partners for the CGS4000 can be found at [www.biohorizons.com](http://www.biohorizons.com).



\* Mount-free Tapered Pro, Tapered Internal, Tapered Plus, Tapered 3.0, Tapered Tissue Level. 5.8mm implant instruments sold separately.

## Tapered Offset Dilator Kit

### TODKIT2 Tapered Offset Site Dilator Kit

The Tapered Implant site dilators match the geometry of the Tapered surgical drills and are used to create or enlarge osteotomies in soft maxillary bone. These instruments compress the bone laterally rather than removing valuable bone from the surgical site, creating a more dense bone-to-implant interface.



## Tapered Ridge Expanders

- TRE30** 3.0mm Tapered Ridge Expander
- TRE34** 3.4mm Tapered Ridge Expander
- TRE38** 3.8mm Tapered Ridge Expander
- TRE42** 4.2mm Tapered Ridge Expander
- TRE46** 4.6mm Tapered Ridge Expander



Refer to L02038 for the surgical protocol.

## Osstell Beacon and Osstell IDx

### OSS-103000 Osstell Beacon

The Osstell Beacon provides an objective and non-invasive method to determine implant stability in a matter of seconds. Measurements are calculated using Resonance Frequency Analysis (RFA) technology, which is based on over 1000 scientific studies.

### OSS-101000 Osstell IDx

The Osstell IDx is a fast, noninvasive and easy to use system to determine implant stability and to assess the process of osseointegration – without jeopardizing the healing process. It provides the accurate, consistent and objective information needed to make well-founded decisions.



## Osstell SmartPegs (packs of 5)

- OSS-100425** 3.0mm platform
- OSS-100440** 3.5mm platform
- OSS-100431** 4.5mm platform
- OSS-100442** 5.7mm platform



# HEALING ABUTMENTS & COVER CAPS

## Laser-Lok Healing Abutments

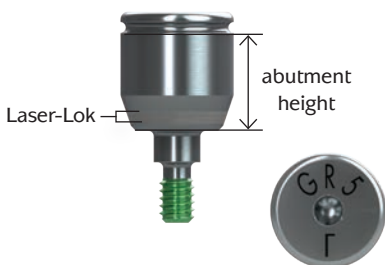

Use Laser-Lok healing abutments when a Laser-Lok abutment restoration is planned to inhibit epithelial downgrowth, establish a soft tissue seal and protect the bone. Refer to the Prosthetic Technique Manual (L02015) for appropriate handling techniques.

- Y = Yellow (3.5mm) platform
- G = Green (4.5mm) platform
- B = Blue (5.7mm) platform
- N, R or W = Narrow, Regular or Wide emergence
- 3 or 5 = 3mm or 5mm abutment height
- L = Laser-Lok

3.0 healing abutments are not laser marked due to their small size.

	abutment diameter	3mm height	5mm height
<b>Narrow Emergence</b>			
3.5mm platform, Laser-Lok	4.0mm	<b>PYNHA3L</b>	<b>PYNHA5L</b>
4.5mm platform, Laser-Lok	5.0mm	<b>PGNHA3L</b>	<b>PGNHA5L</b>
5.7mm platform, Laser-Lok	6.0mm	<b>PBNHA3L</b>	<b>PBNHA5L</b>
<b>Regular Emergence</b>			
3.0mm platform, Laser-Lok	3.5mm	<b>TP3HA3L</b>	<b>TP3HA5L</b>
3.5mm platform, Laser-Lok	4.5mm	<b>PYRHA3L</b>	<b>PYRHA5L</b>
4.5mm platform, Laser-Lok	5.5mm	<b>PGRHA3L</b>	<b>PGRHA5L</b>
5.7mm platform, Laser-Lok	6.5mm	<b>PBRHA3L</b>	<b>PBRHA5L</b>
<b>Wide Emergence</b>			
3.0mm platform, Laser-Lok	4.0mm	<b>TP3WHA3L</b>	<b>TP3WHA5L</b>
3.5mm platform, Laser-Lok	6.0mm	<b>PYWHA3L</b>	<b>PYWHA5L</b>
4.5mm platform, Laser-Lok	7.0mm	<b>PGWHA3L</b>	<b>PGWHA5L</b>

## Cover Caps



- TP3CC** 3.0mm Cover Cap
- PYCC** 3.5mm Cover Cap
- PGCC** 4.5mm Cover Cap
- PBCC** 5.7mm Cover Cap

Use during submerged surgical healing. Hand-tighten with the .050" (1.25mm) Hex Driver. Titanium Alloy. *Included with implant but can also be ordered separately.*



# HEALING ABUTMENTS

## Standard Healing Abutments

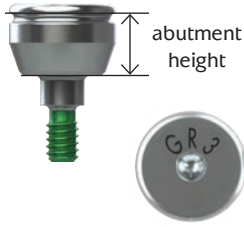

Hand-tighten with the .050" (1.25mm) Hex Driver. Titanium Alloy.

The 3.5mm, 4.5mm and 5.7mm healing abutments are laser marked for easy intraoral identification of the prosthetic platform, emergence and height:

- Y = Yellow (3.5mm) platform
- G = Green (4.5mm) platform
- B = Blue (5.7mm) platform
- N, R or W = Narrow, Regular or Wide emergence
- 1, 2, 3 or 5 = 1mm, 2mm, 3mm or 5mm abutment height

3.0 healing abutments are not laser marked due to their small size.

	abutment diameter	1mm height	2mm height	3mm height	5mm height
<b>Narrow Emergence</b>					
3.0mm platform	3.5mm	-	<b>TP3NHA2</b>	<b>TP3NHA3</b>	<b>TP3NHA5</b>
3.5mm platform	4.0mm	<b>PYNHA1</b>	<b>PYNHA2</b>	<b>PYNHA3</b>	<b>PYNHA5</b>
4.5mm platform	5.0mm	<b>PGNHA1</b>	<b>PGNHA2</b>	<b>PGNHA3</b>	<b>PGNHA5</b>
5.7mm platform	6.0mm	<b>PBNHA1</b>	<b>PBNHA2</b>	<b>PBNHA3</b>	<b>PBNHA5</b>
<b>Regular Emergence</b>					
3.0mm platform	3.5mm	-	<b>TP3HA2</b>	<b>TP3HA3</b>	<b>TP3HA5</b>
3.5mm platform	4.5mm	-	<b>PYRHA2</b>	<b>PYRHA3</b>	<b>PYRHA5</b>
4.5mm platform	5.5mm	-	<b>PGRHA2</b>	<b>PGRHA3</b>	<b>PGRHA5</b>
5.7mm platform	6.5mm	-	<b>PBRHA2</b>	<b>PBRHA3</b>	<b>PBRHA5</b>
<b>Wide Emergence</b>					
3.0mm platform	4.0mm	-	-	<b>TP3WHA3</b>	<b>TP3WHA5</b>
3.0mm platform (extra wide)	5.0mm	-	-	<b>TP3EWA3</b>	<b>TP3EWA5</b>
3.5mm platform	6.0mm	-	-	<b>PYWHA3</b>	<b>PYWHA5</b>
4.5mm platform	7.0mm	-	-	<b>PGWHA3</b>	<b>PGWHA5</b>
5.7mm platform	8.0mm	-	-	<b>PBWHA3</b>	<b>PBWHA5</b>

## Healing Abutments (Tapered Tissue Level)

	abutment diameter	2mm height	3mm height	4mm height
3.5mm platform	5.0mm	<b>SYHA20</b>	<b>SYHA30</b>	<b>SYHA40</b>
4.5mm platform	6.0mm	<b>SGHA20</b>	<b>SGHA30</b>	<b>SGHA40</b>
5.7mm platform	7.5mm	<b>SBHA20</b>	<b>SBHA30</b>	<b>SBHA40</b>



For Tapered Tissue Level implants only. Hand-tighten with the .050" (1.25mm) Hex Driver. Titanium Alloy. Laser marked for easy intraoral identification; for example: **SG2**: Green (4.5mm) platform / 2mm height.

# TEMPORARY ABUTMENTS



Using authentic BioHorizons parts will ensure a precision fit connection between the prosthetic component and implant, avoiding costly component failures that may occur from using third-party prosthetics. Authentic BioHorizons parts are color-coded for easy identification to match the mating implant.

## advantages:

- lifetime warranty on all implants and prosthetics
- Spiralock® technology minimizes screw loosening
- precise mating geometries reduce prosthetic failures
- advanced design creates a better engineered connection
- color-coded prosthetic components match implant platforms

## Laser-Lok Easy Ti Temp Abutments

<b>TP3ETHL</b>	<b>3.0mm platform, hexed</b>	<b>TP3ETNL</b>	<b>3.0mm platform, non-hexed</b>
<b>PYETHL</b>	<b>3.5mm platform, hexed</b>	<b>PYETNL</b>	<b>3.5mm platform, non-hexed</b>
<b>PGETHL</b>	<b>4.5mm platform, hexed</b>	<b>PGETNL</b>	<b>4.5mm platform, non-hexed</b>
<b>PBETHL</b>	<b>5.7mm platform, hexed</b>	<b>PBETNL</b>	<b>5.7mm platform, non-hexed</b>

Use hexed for single-unit screw retained, long term temporary restorations that require superior esthetics (>30 days). Use non-hexed for multiple-unit, screw retained, long term temporary restorations (>30 days). Packaged with an abutment screw (PXAS). Titanium Alloy for strength. TiN coated for esthetics. Final torque: 30Ncm. Refer to the Prosthetic Technique Manual (L02015) for appropriate handling techniques

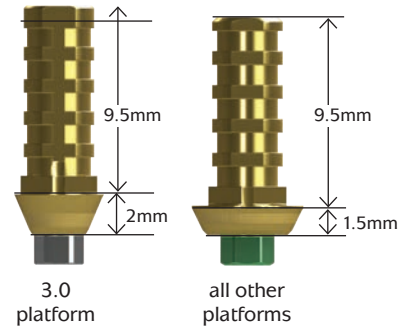

## Laser-Lok Easy Ti Temp Sleeves

<b>TP3ETS</b>	<b>3.0mm platform (pack of 3)</b>
<b>PXETS</b>	<b>3.5mm, 4.5mm &amp; 5.7mm platform (pack of 3)</b>

Use to create a wax-up of abutment for Easy Ti Temp Abutments. Packaged in packs of three. Acetal resin (Delrin® or Pomalux®) sleeve.

<b>TP3ETPS</b>	<b>3.0mm platform (pack of 3), PEEK</b>
<b>PXETPS</b>	<b>3.5mm, 4.5mm &amp; 5.7mm platform (pack of 3), PEEK</b>

Use for fabrication of cement- or screw-retained provisional restorations (>30 days). Packaged in packs of three. PEEK (PolyEtherEtherKetone) material.

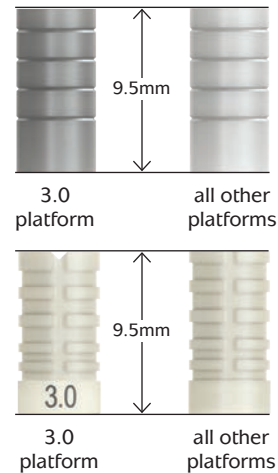

## PEEK Temporary Cylinder Abutments

	hexed	non-hexed
3.0mm platform	TP3PTC	TP3PTCN
3.5mm platform	PYPTC	PYPTCN
4.5mm platform	PGPTC	PGPTCN
5.7mm platform	PBPTC	PBPTCN

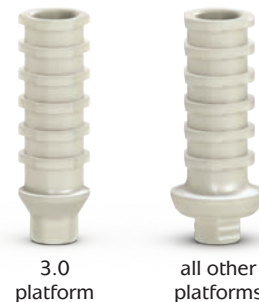

Use for fabrication of cement- or screw-retained provisional restorations (up to 30 days). A direct coping screw (PXDCS, purchased separately) may be used to maintain screw access hole during fabrication of screw-retained provisional prostheses. Packaged with an abutment screw (PXAS). PEEK (PolyEtherEtherKetone) material. Final torque: 30Ncm.

# INSTRUCTIONS FOR USE

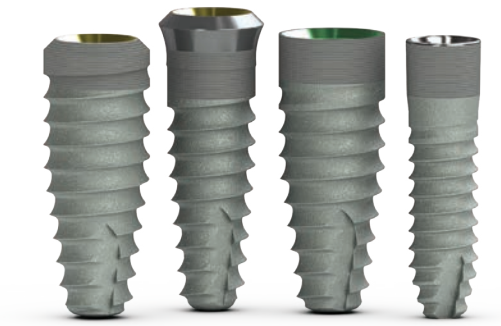

This surgical manual serves as a reference for using the Tapered Internal, Tapered Plus and Tapered Tissue Level implants and surgical instruments. It is intended solely to provide instructions on the use of BioHorizons products. It is not intended to describe the methods or procedures for diagnosis, treatment planning, or placement of implants, nor does it replace clinical training or a clinician's best judgment regarding the needs of each patient. BioHorizons strongly recommends appropriate training as a prerequisite for the placement of implants and associated treatment.

The procedures illustrated and described within this manual reflect idealized patient presentations with adequate bone and soft tissue to accommodate implant placement. No attempt has been made to cover the wide range of actual patient conditions that may adversely affect surgical and prosthetic outcomes. **Clinician judgment as related to any specific case must always supersede any recommendations made in this or any BioHorizons literature.**

Before beginning any implant surgical procedure with BioHorizons implants:



- Read and understand the Instructions for Use that accompany the products.
- Clean and sterilize the surgical tray and instruments per Instructions for Use.
- Become thoroughly familiar with all instruments and their uses.
- Study surgical kit layout and iconography.
- Design a surgical treatment plan to satisfy the prosthetic requirements of the case.



Small diameter implants are intended for the anterior region of the mouth and are not intended for the posterior region of the mouth due to possible failure of the implant.

## Indications

Tapered Internal, Tapered Plus and Tapered Tissue Level Implants are intended for use in the mandible or maxilla as an artificial root structure for single tooth replacement or for fixed bridgework and dental retention. The implants may be restored immediately:

- 1) with a temporary prosthesis that is not in functional occlusion or
- 2) when splinted together for multiple tooth replacement or when stabilized with an overdenture supported by multiple implants.

Tapered Internal 3.0 and Tapered Tissue Level 3.0 Implants may be used as an artificial root structure for single tooth replacement of mandibular central and lateral incisors and maxillary lateral incisors. The implants may be restored immediately:

- (1) with a temporary prosthesis that is not in functional occlusion,
- (2) when splinted together as an artificial root structure for multiple tooth replacement of mandibular incisors,
- (3) for denture stabilization using multiple implants in the anterior mandible and maxilla.

The implants may be placed in immediate function when good primary stability has been achieved and with appropriate occlusal loading.

# SURGICAL PROTOCOLS

## Two-Stage Protocol

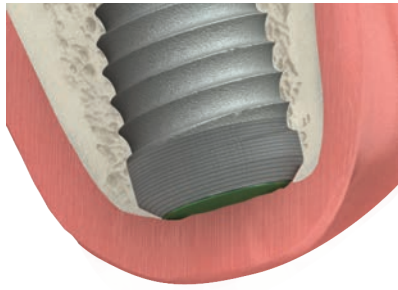

Implant with cover cap in a two-stage protocol.

In a two-stage surgery, the implant is placed below the soft tissue and protected from occlusal function and other forces during osseointegration. A low-profile cover cap is placed on the implant to protect it from the ingress of soft tissue.

Following osseointegration, a second procedure exposes the implant and a transmucosal healing abutment is placed to allow for soft tissue healing and development of a sulcus. Prosthetic restoration begins after soft tissue healing.

## Single-Stage Protocol

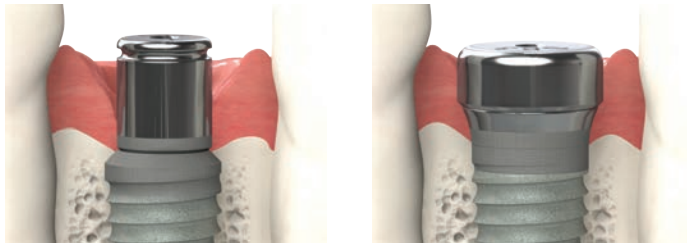

Tapered Plus with healing abutment in a single-stage protocol.

Tapered Tissue Level with healing abutment in a single-stage protocol.

Single-stage surgery may be accomplished by placing a healing abutment at the time of implant surgery. This eliminates the need for a second procedure. Although the implant is not in occlusal function, some forces can be transmitted to it through the exposed transmucosal element.

Prosthetic restoration begins following osseointegration of the implant and soft tissue healing.

## Non-functional Immediate Restoration



Implant restored with a non-functional provisional prosthesis.

Single-stage surgery with non-functional immediate provisionalization provides the patient a non-functioning provisional prosthesis early in the treatment plan. An abutment is placed on the implant at or shortly after surgery, and a provisional restoration is secured using temporary cement. The provisional can help contour the soft tissue profile during healing.

## Immediate Function Restoration

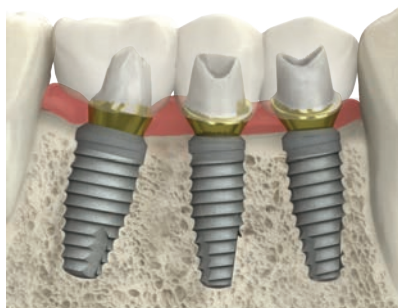

Implants with a splinted prosthesis in immediate function.

Single-stage surgery with immediate function is possible in good quality bone where multiple implants exhibiting excellent initial stability can be splinted together. Splinting implants together may offer a biomechanical advantage over individual, unsplinted prostheses.



# IMPLANT PLACEMENT LEVEL & SPACING

## Placement in Uneven Ridges

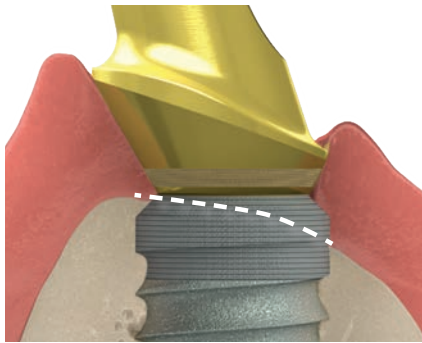

When placing the implant in an uneven ridge, prepare the osteotomy and place the implant so the bone/soft-tissue junction is within the Laser-Lok transition zone. This will allow both soft tissue and bone to attach to the Laser-Lok collar. If the ridge discrepancy is more than the Laser-Lok transition zone, leveling the ridge can be considered.

## Implant-to-Tooth Spacing

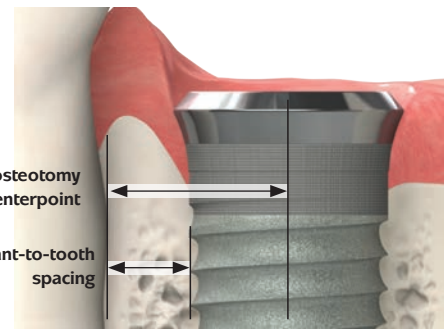
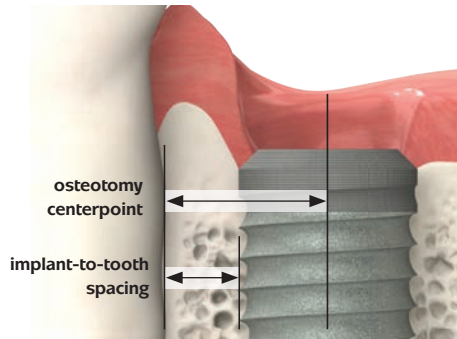

The osteotomy centerpoint required to maintain a specific implant-to-tooth spacing is calculated according to this formula:  
 **$1/2$  (implant body diameter) + the desired spacing.**



*During implant placement, clinicians must apply their best judgment as to the appropriate spacing for individual patient conditions.*

## Implant-to-Implant Spacing

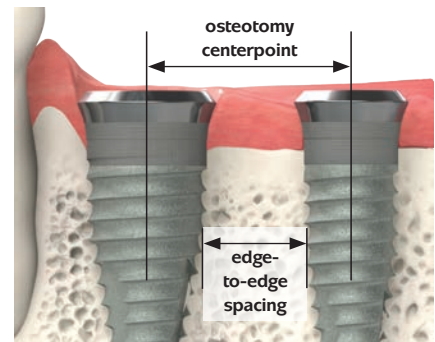
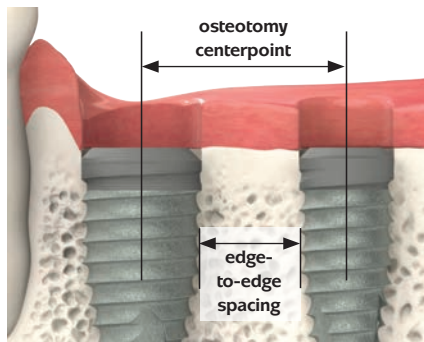

The osteotomy center-to-center measurement required to maintain a specific edge-to-edge spacing between two implants is calculated according to this formula:  **$1/2$  (sum of 2 implant body diameters) + the desired spacing.**



*During implant placement, clinicians must apply their best judgment as to the appropriate spacing for individual patient conditions.*

# SURGICAL KIT & DRILL SEQUENCE

## Surgical Kit Instructions

The surgical kit uses an intuitive layout to guide the surgeon through the instrument sequence. The sequence begins in the upper left hand corner and works left-to-right and then down.

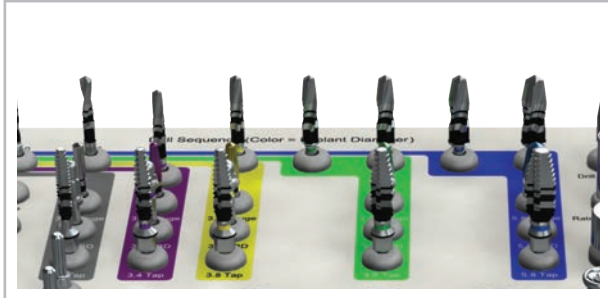

The drilling section is color-coded by implant body diameter (gray=3.0mm, purple=3.4mm, yellow=3.8mm, green=4.6mm and blue=5.8mm).



The implant driver section is color-coded by prosthetic platform (gray=3.0mm, yellow=3.5mm, green=4.5mm and blue=5.7mm).



abutment-level drivers are only for mounted implants.

Prior to use, clean and sterilize the surgical tray and instruments according to the Instructions for Use included with the kit. Study the surgical kit layout, color coding and iconography. Surgical assistants should be thoroughly familiar with all instruments and their uses prior to initiating the surgical procedure.

## Drill Sequence

<p><b>3.0mm</b> body diameter</p> <p><b>3.4mm</b> body diameter</p> <p><b>3.8mm</b> body diameter</p> <p><b>4.6mm</b> body diameter</p> <p><b>5.8mm</b> body diameter</p>						
		<p>HD Drill Sequence</p> <p>Recommended speed 1,500 - 2,000 RPM</p>	<p>HD Depth Gauge</p> <p>Recommended speed 1,000 RPM</p>	<p>HD Crestal Bone Drill (site specific)</p> <p>Recommended speed 1,000 RPM</p>	<p>HD Bone Tap (site specific)</p> <p>Maximum 30 RPM or use manually</p>	<p>Implant Driver</p> <p>Maximum 30 RPM or use manually</p>

Note: The 2.8mm drill is used for the 3.4mm diameter implant, it is not needed for other sizes.

# DRILL OVERVIEW

## Drill Markings

All surgical drills included with this system are externally irrigated and designed to be used with steady sterile irrigation. Reduced drill speed may be indicated in softer bone or as drill diameter increases.

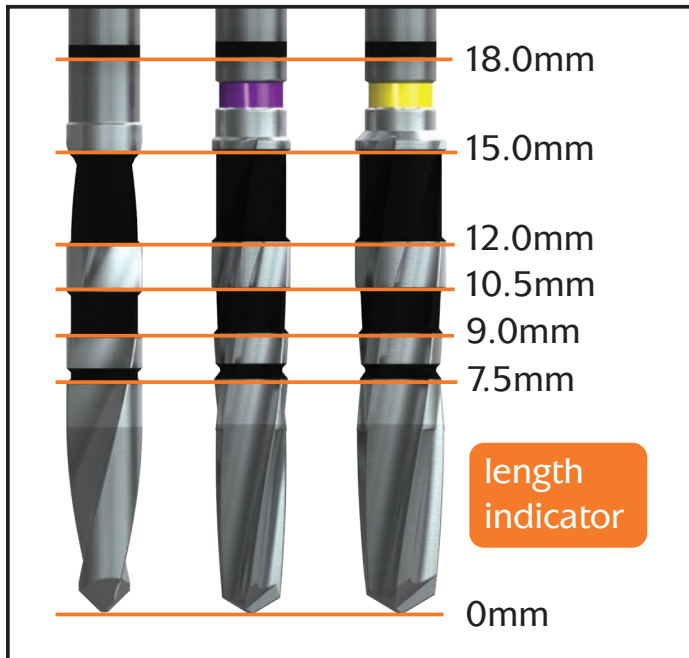

**Note: The depth marks are consistent throughout the starter drills, depth drills and width increasing drills**

## Important Considerations

- Peri-operative oral rinses with a 0.12% Chlorhexidine Digluconate solution have been shown to significantly lower the incidence of post-implantation infectious complications.<sup>13</sup> A pre-operative 30-second rinse is recommended, followed by twice daily rinses for two weeks following surgery.
- Drilling must be done under a constant stream of sterile irrigation. A pumping motion should be employed to prevent over-heating the bone. Surgical drills and taps should be replaced when they are worn, dull, corroded or in any way compromised. BioHorizons recommends replacing drills after 12 to 20 osteotomies.<sup>14</sup> A Drill-usage Tracking Chart is available at [biohorizons.com](http://biohorizons.com) to record this important information.
- There is a risk of injury to the mandibular nerve associated with surgical drilling in posterior mandibular regions. To minimize the risk of nerve injury, it is imperative that the clinician understands the drill depth markings as they relate to the implant length to produce the desired vertical placement of the implant.

# OSTEOTOMY INITIALIZATION

## 2.0mm HD Drill



### 2.0mm Starter Drill

**Purpose:** Initiate osteotomy.

- Chisel-tip design eliminates "skating" on osseous crest
- Prepares site for paralleling pins
- Matte finish for increased visibility under operatory lights
- 1,500 - 2,000 RPM

## 2.5mm HD Drill



### 2.5mm Depth Drill

**Purpose:** Set osteotomy depth.

- Efficient cutting drill design collects bone for autografting
- Matte finish for increased visibility under operatory lights
- Final drill for 3.0mm implants
- 1,500 - 2,000 RPM

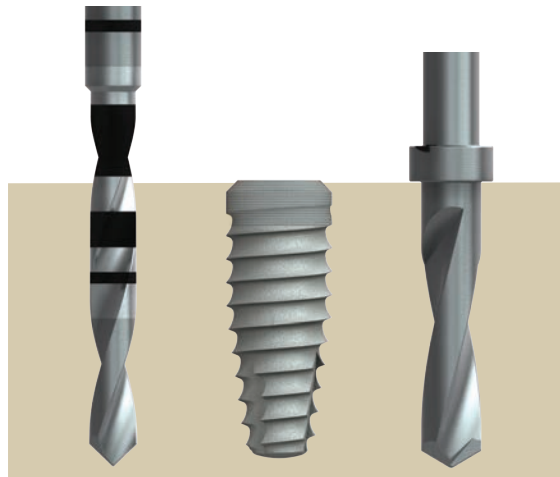

The 2.0mm and 2.5mm depth drills are designed to increase and/or set the depth of the osteotomy.

## 2.5mm Depth Drills with Stops



**Purpose:** Set osteotomy depth when access or visibility is poor.

- Fixed circular ring acts as a definitive drill stop
- One drill length for each implant length
- 1 mm laser-etched line guides supracrestal implant placement
- Surgical Kit includes spare slots for depth drills with stops or extended shank drills
- Optional final drill for 3.0mm implants
- 1,500 - 2,000 RPM

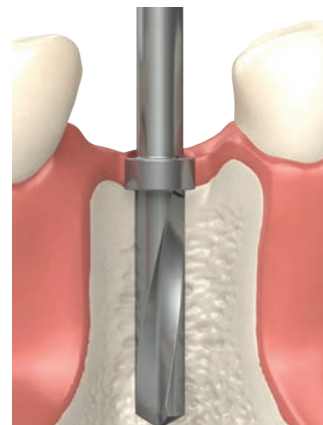

# OSTEOTOMY MODIFICATION

## Paralleling Pins



**Purpose:** Evaluate osteotomy position and angle.

- Provided straight or with a 20° angle
- Use after 2.0mm Starter Drill and 2.5mm Depth Drill
- 9mm shank for radiographic evaluation of proximity to adjacent anatomy
- Hub diameter is 4.0mm

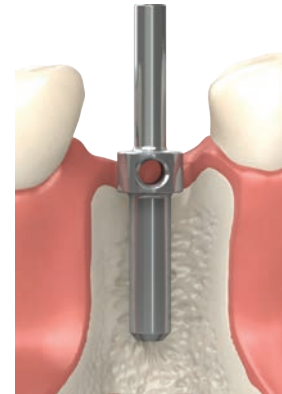

## HD Drills



**Purpose:** Incrementally widen the osteotomy to reduce heat generation.

- Depth-marked for reference
- Efficient cutting drill design collects bone for autografting
- The drill tip has limited end cutting. However, the osteotomy depth can be increased with these drills as needed
- Matte finish for increased visibility under operatory lights
- Color-coded by implant body diameter (gray=3.0mm, purple=3.4mm, yellow=3.8mm, green=4.6mm and blue=5.8mm)
- 1,000 RPM



## HD Depth Gauges



**Purpose:** To visualize final osteotomy diameter and location.

- Depth-marked for reference
- Use following the final width increasing drill for each implant
- Place the depth gauge into the osteotomy site, adjust osteotomy depth as necessary
- Can also be used after 2mm drill by inverting
- Color-coded by implant body diameter (gray=3.0mm, purple=3.4mm, yellow=3.8mm, green=4.6mm and blue=5.8mm)

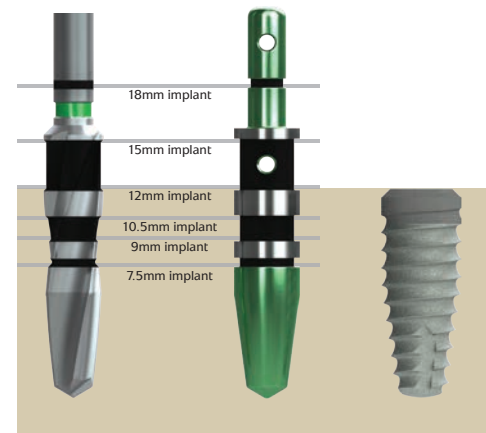

HD drill

HD Depth gauge

12mm implant with Laser-Lok



# FINAL BONE PREPARATION & DRIVERS

## HD Crestal Bone Drills



**Purpose:** Remove cortical bone at ridge crest for pressure-free seating of the implant collar.

- Use when dense cortical bone is present at crest
- Rounded non-end cutting hub centers drill in osteotomy
- Use following the final width increasing drill for each implant
- Color-coded by implant body diameter (gray=3.0mm, purple=3.4mm, yellow=3.8mm, green=4.6mm and blue=5.8mm)
- 1,000 RPM

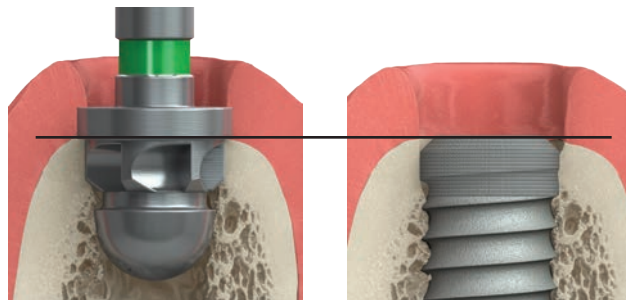

Seat drill to the first line.

Implant level with osseous crest.

## HD Bone Taps



**Purpose:** Prepare dense cortical bone for implant threads.

- Site specific
- Final instrument prior to implant placement
- Can be driven with a handpiece, ratchet or hand wrench
- Color-coded by implant body diameter (gray=3.0mm, purple=3.4mm, yellow=3.8mm, green=4.6mm and blue=5.8mm)
- 30 rpm or less<sup>15</sup>

Place into the osteotomy, apply firm apical pressure and rotate slowly in a clockwise direction. When the threads engage, allow the tap to feed without excessive pressure. To remove, rotate the bone tap in a counter-clockwise direction, allowing it to back out of the osteotomy.

*Do not pull on the bone tap to remove it from the site.*



## Implant & Abutment Drivers



**Purpose:** Engage the implant's internal hex/abutment internal square to drive implants into the osteotomy

- Implant level drivers are color-coded by prosthetic connection:
- gray=3.0mm platform
- yellow/green=3.5/4.5mm platform
- blue=5.7mm platform
- 30 rpm or less<sup>15</sup>



# IMPLANT TRANSFER

## Implant Pick-up

Vial caps are color coded by body diameter (3.0mm=white, 3.4mm=purple, 3.8mm=yellow, 4.6mm=green, 5.8mm=blue). Cover caps and implant drivers are color-coded by prosthetic platform (3.0mm=gray, 3.5mm=yellow, 4.5mm=green, 5.7mm=blue).

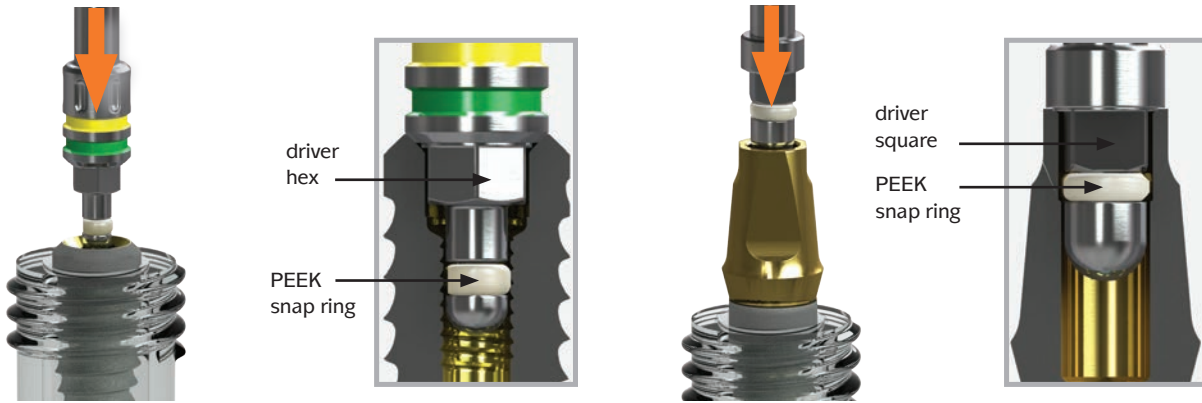

### Mount-free implants

To pick-up the implant, align the driver hex with the implant hex and press firmly to engage the PEEK snap ring.

### Mounted implants

To pick-up the implant, engage the 3inOne Abutment or Implant with the PEEK snap ring of the appropriate abutment-level driver. The driver square has no retentive feature and does not need to be engaged. The driver will completely engage when the driver/implant is slowly rotated into the osteotomy under apical pressure.

## Implant Placement

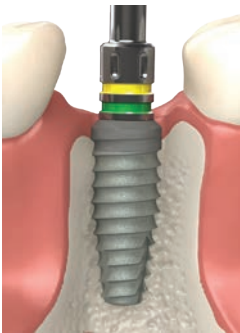

Place the apex of the implant into the osteotomy and begin rotating slowly. The driver hex will engage when the driver is slowly rotated under apical pressure. If too much resistance is felt during insertion, remove the implant and revise the osteotomy with the appropriate crestal bone drill or bone tap as deemed necessary to reduce insertion torque.



**!** When placing mounted implants, do not exceed 120 Ncm of torque. If torque limit is met prior to full placement, remove the 3inOne abutment and complete placement using an implant-level driver.

## Internal Hex Orientation

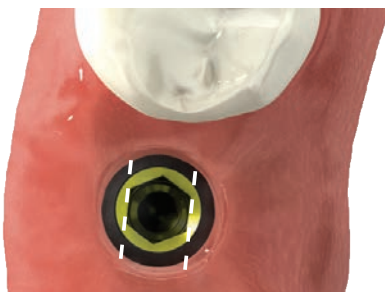

When seating the implant, use the corresponding dimples on the driver to orient one internal hex flat perpendicular to the implant angulation plane. Doing so verifies that an angled abutment will correct the angulation.

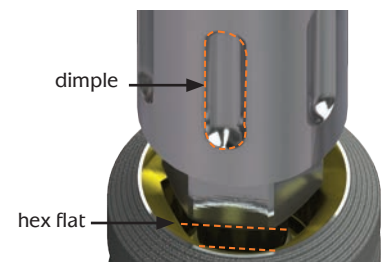

## Cover Caps for Two-stage Protocol



**Purpose:** Protects prosthetic platform in two-stage (submerged) surgical protocol for bone level implants.

- Irrigate implant to remove blood and other debris:
- Use an antibacterial paste to decrease the risk of bacterial growth
- Thread clockwise into implant body
- Color-coded by prosthetic platform
- Hand-tighten (10-15 Ncm) utilizing .050" (1.25mm) Hex Driver

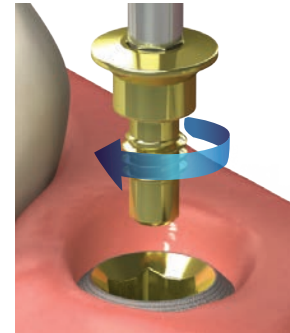

cover cap

The cover cap for the mount-free implant is mounted in the vial cap.



implant

cover cap

The cover cap for the mounted implant is mounted on a plastic base underneath the implant.

## Healing Abutments for Single-stage Protocol



**Purpose:** Transmucosal element for developing soft tissue emergence with narrow, regular, wide emergence or Simple Solutions prosthetic components.

- Color-coded by prosthetic platform
- The 3.5, 4.5mm and 5.7mm healing abutments are laser marked for easy intraoral identification; for example: YR3=Yellow (3.5mm) platform / Regular Emergence / 3mm High
- If a Laser-Lok temporary or final restoration is planned, a Laser-Lok healing abutment is required
- Hand-tighten (10-15 Ncm) utilizing .050" (1.25mm) Hex Driver



## Immediate Provisional Restorative Options



### Temporary Abutments

**Purpose:** Titanium and PEEK temporaries are easily modified for fabrication of cement or screw-retained provisional restorations. A long direct coping screw (purchased separately) may be used to maintain the screw access hole during the fabrication of a screw-retained provisional prosthesis.



### Simple Solutions with Laser-Lok

**Purpose:** When a Simple Solutions restoration is planned, the tooth-colored healing cap that comes packaged with the abutment may be used as a coping for an immediate provisional restoration. See L01017 or L02007 for more information.

## Bone Profilers



**Purpose:** In cases where excess crestal bone has been created, use a bone profiler at implant uncover to contour the bone. This will provide the necessary clearance for proper abutment seating.

- Profiler guide protects implant platform
- Color-coded by prosthetic platform (gray=3.0mm, yellow=3.5mm, green=4.5mm, blue=5.7mm)
- 800 rpm drill speed with steady sterile irrigation

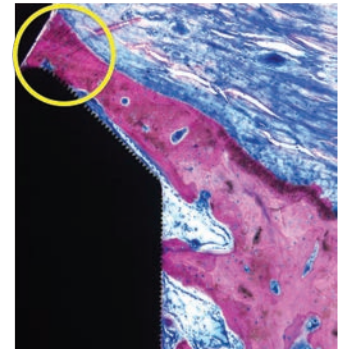

*Image showing exceptional bone growth at 3 months. (Myron Nevins, DDS.)*

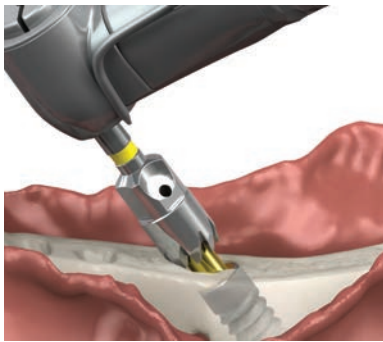

Do not use the profiler without the guide in place.

Using an .050" hex driver, remove the surgical cover cap from the implant and place the profiler guide that matches the color of the prosthetic platform. Use the profiler with copious amounts of sterile irrigation. Once the excess bone and soft tissue are removed, unscrew the guide and seat the appropriate prosthetic component.

## Post-operative Instructions

A period of unloaded healing time is often recommended to allow for integration between the bone and implant surface. This is dependent on individual patient healing rates and bone quality of the implant site. Each case must be independently evaluated.

The patient should be instructed to follow a post-surgical regimen including cold packs for 24 hours post-implantation. The patient's diet should consist of soft foods and possibly dietary supplements. Pharmacological therapy should be considered as the patient's condition dictates.

If a removable prosthesis is used during the initial healing phase, a soft liner material should be used to prevent pressure on the surgical site. Relieve the prosthesis over the implant site prior to the soft liner application. Periodically check the patient's soft tissue and bone healing using clinical and radiographic evaluations.

Ongoing hygiene for the implant patient is vital. Hygiene recall appointments at three month intervals are suggested. Instruments designed for implant abutment scaling, such as Implacare® instruments from Hu-Friedy® should be utilized. The stainless steel handles may be fitted with assorted tip designs for hygiene on natural teeth. The Implacare® scalers contain no glass or graphite fillers that can scratch titanium implant abutments.

Symbol Descriptions for Product Labeling

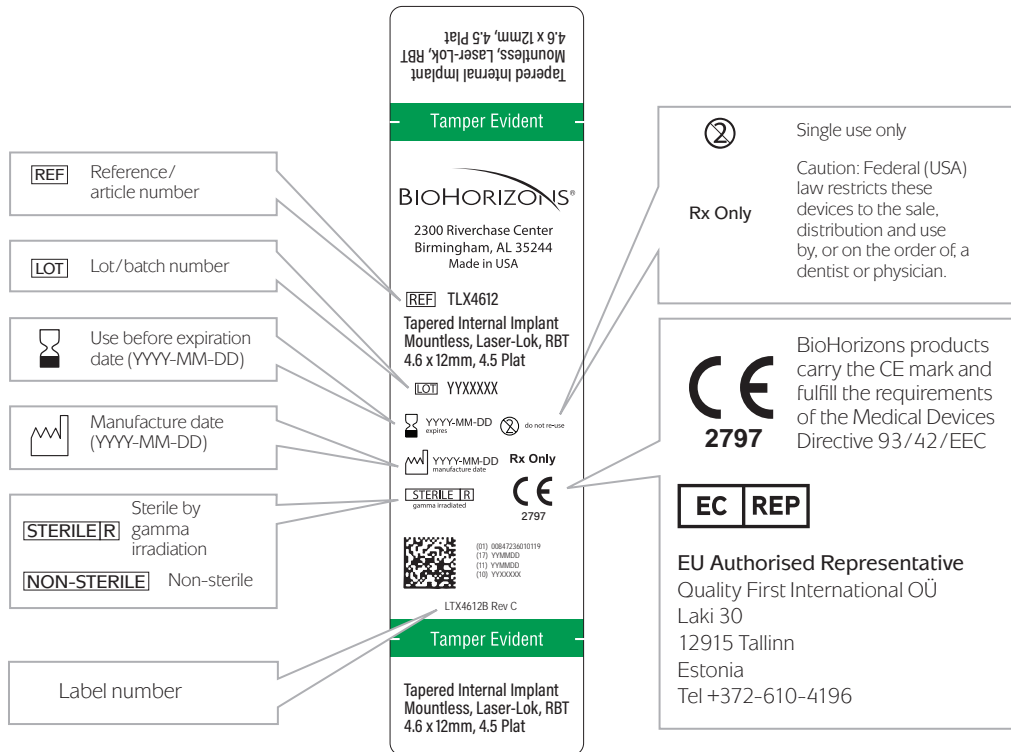

Tapered Plus Product Labeling



body diameter	prosthetic platform
<b>3.8mm</b> (yellow box label, vial cap & white blister label)	<b>3.0mm</b> (gray internal hex & cover cap)
<b>4.6mm</b> (green box label, vial cap & white blister label)	<b>3.5mm</b> (yellow internal hex & cover cap)
<b>5.8mm</b> (blue box label, vial cap & white blister label)	<b>4.5mm</b> (green internal hex & cover cap)

Tapered Internal Product Labeling



body diameter	prosthetic platform
<b>3.0mm</b> (gray box label, white blister label & vial cap)	<b>3.0mm</b> (gray internal hex & cover cap)
<b>3.4mm</b> (purple box label, blister label & vial cap)	<b>3.0mm</b> (gray internal hex & cover cap)
<b>3.8mm</b> (yellow box label, blister label & vial cap)	<b>3.5mm</b> (yellow internal hex & cover cap)
<b>4.6mm</b> (green box label, blister label & vial cap)	<b>4.5mm</b> (green internal hex & cover cap)
<b>5.8mm</b> (blue box label, blister label & vial cap)	<b>5.7mm</b> (blue internal hex & cover cap)

Tapered Tissue Level Product Labeling



body diameter	prosthetic platform
<b>3.0mm</b> (gray box label, white blister label & vial cap)	<b>3.5mm</b> (yellow internal hex & cover cap)
<b>3.8mm</b> (yellow box label, blister label & vial cap)	<b>3.5mm</b> (yellow internal hex & cover cap)
<b>4.6mm</b> (green box label, blister label & vial cap)	<b>4.5mm</b> (green internal hex & cover cap)
<b>5.8mm</b> (blue box label, blister label & vial cap)	<b>5.7mm</b> (blue internal hex & cover cap)



# ORDERING, WARRANTY INFORMATION AND REFERENCES

**Territory Manager:** \_\_\_\_\_

**cell phone:** \_\_\_\_\_

**email and/or fax:** \_\_\_\_\_

**BioHorizons Lifetime Warranty on Implants and Prosthetics:** All BioHorizons implants and prosthetic components include a Lifetime Warranty. BioHorizons implant or prosthetic components will be replaced if removal of that product is due to failure (excluding normal wear to overdenture attachments).

**Additional Warranties:** BioHorizons warranties surgical drills, taps and other surgical and restorative instruments.

**(1) Surgical Drills and Taps:** Surgical drills and taps include a warranty period of ninety (90) days from the date of initial invoice. Surgical instruments should be replaced when they become worn, dull, corroded or in any way compromised. Surgical drills should be replaced after 12 to 20 osteotomies.<sup>14</sup>

**(2) Instruments:** The BioHorizons manufactured instrument warranty extends for a period of one (1) year from the date of initial invoice. Instruments include drivers, implant site dilators and BioHorizons tools used in the placement or restoration of BioHorizons implants.

**Return Policy:** Product returns require a Return Authorization Form, which may be acquired by contacting Customer Care. The completed Return Authorization Form must be included with the returned product. For more information, please see the reverse side of the invoice that was shipped with the product.

**Disclaimer of Liability:** BioHorizons products may only be used in conjunction with the associated original components and instruments according to the Instructions for Use (IFU). Use of any non-BioHorizons products in conjunction with BioHorizons products will void any warranty or any other obligation, expressed or implied.

Treatment planning and clinical application of BioHorizons products are the responsibility of each individual clinician. BioHorizons strongly recommends completion of postgraduate dental implant education and adherence to the IFU that accompany each product. BioHorizons is not responsible for incidental or consequential damages or liability relating to use of our products alone or in combination with other products other than replacement or repair under our warranties.

**Distributed Products:** For information on the manufacturer's warranty of distributed products, please refer to their product packaging. Distributed products are subject to price change without notice.

**Validity:** Upon its release, this literature supersedes all previously published versions.

**Availability:** Not all products shown or described in this literature are available in all countries. BioHorizons continually strives to improve its products and therefore reserves the right to improve, modify, change specifications or discontinue products at any time.

Any images depicted in this literature are not to scale, nor are all products depicted. Product descriptions have been modified for presentation purposes. For complete product descriptions and additional information, visit [store.biohorizons.com](http://store.biohorizons.com).

## References

1. *Incidence of Peri-Implant Diseases on Implants with and without Laser-Microgrooved Collar: A 5-Year Retrospective Study Carried Out in Private Practice Patients.* Guarneri R, Grande M, Zuffetti F, Testori T. *Int J Oral Maxillofac Implants.* 2018 Mar/Apr;33(2):457-465.
2. *For a complete research summary, please see Laser-Lok Clinical Overview (BioHorizons document ML0606).*
3. *Human histologic evidence of a connective tissue attachment to a dental implant.* M Nevins, ML Nevins, M Camelo, JL Boyesen, DM Kim. *International Journal of Periodontics & Restorative Dentistry.* Vol. 28, No. 2, 2008.
4. *The effects of laser microtextured collars upon crestal bone levels of dental implants.* S Weiner, J Simon, DS Ehrenberg, B Zweig, JL Ricci. *Implant Dentistry, Volume 17, Number 2, 2008.* p. 217-228.
5. *Influence of a microgrooved collar design on soft and hard tissue healing of immediate implanta-tion in fresh extraction sites in dogs.* SY Shin, DH Han. *Clin. Oral Impl. Res.* 21, 2010; 804-814.
6. *Maintaining inter-implant crestal bone height via a combined platform-switched, Laser-Lok® im-plant/abutment system: A proof-of-principle canine study.* M Nevins, ML Nevins, L Gobbato, HJ Lee, CW Wang, DM Kim. *Int J Periodontics Restorative Dent.* Volume 33, Number 3, 2013.
7. *Histologic evidence of a connective tissue attachment to laser microgrooved abutments: A canine study.* M Nevins, DM Kim, SH Jun, K Guze, P Schupbach, ML Nevins. *International Journal of Periodontics & Restorative Dentistry.* Vol. 30, No. 3, 2010.
8. *Histologic evidence of connective tissue integration on laser microgrooved abutments in humans.* NC Geurs, PJ Vassilopoulos, MS Reddy. *Clinical Advances in Periodontics.* Vol. 1, No. 1, May 2011.
9. *Connective tissue attachment to laser microgrooved abutments: A human histologic case report.* M Nevins, M Camelo, ML Nevins, P Schupbach, DM Kim. *Int J Periodontics Restorative Dent.* Volume 32, Number 4, 2012. p. 384-392.
10. *Reattachment of the connective tissue fibers to the laser microgrooved abutment surface.* M Nevins, M Camelo, ML Nevins, P Schupbach, DM Kim. *Int J Periodontics Restorative Dent.* Volume 32, Number 4, 2012. e131-134.
11. *The impact of dis-/reconnection of laser microgrooved and machined implant abutments on soft- and hard-tissue healing.* Ighhaut G, Becker K, Golubovic V, Schliephake H, Mihatovic I. *Clin Oral Implants Res.* 2013 Apr;24(4):391-7.
12. *The effects of laser microtexturing of the dental implant collar on crestal bone levels and peri-implant health.* S Botos, H Yousef, B Zweig, R Flinton and S Weiner. *Int J Oral Maxillofac Im-plants.* 2011 ;26:492-498.
13. *The influence of 0.12 percent chlorhexidine digluconate rinses on the incidence of infectious com-plexions and implant success.* Lambert PM, Morris HF, Ochi S. *J Oral Maxillofac Surg* 1997;55(12 suppl-ment 5):25-30.
14. *Heat production by 3 implant drill systems after repeated drilling and sterilization.* Chacon GE, Bower DL, Larsen PE, McGlumphy EA, Beck FM. *J Oral Maxillofac Surg.* 2006 Feb;64(2):265-9.
15. *Root Form Surgery in the Edentulous Mandible: Stage I Implant Insertion.* CE Misch. *Contemporary Implant Dentistry Second Edition.* Mosby: St. Louis, 1999. 347-369.

## Direct Offices

**BioHorizons USA**  
888-246-8338 or  
205-967-7880

**BioHorizons Canada**  
866-468-8338

**BioHorizons Spain**  
+34 91 713 10 84

**BioHorizons UK**  
+44 (0)1344 752560

**BioHorizons Chile**  
+56 (2) 23619519

**BioHorizons Italy**  
800-063-040

**BioHorizons Mexico**  
800-953-0498

## Distributors

For contact information in our 90 countries, visit [biohorizons.com](http://biohorizons.com)



BioHorizons®, Laser-Lok®, MinerOss®, AutoTac®, Mem-Lok® and TeethXpress® are registered trademarks of BioHorizons. Unigrip™ is a trademark of Nobel Biocare AB. Zimmer® Dental ScrewVent® and Tapered ScrewVent® are registered trademarks of Zimmer, Inc. AlloDerm™ and AlloDerm GBR™ are trademarks of LifeCell Corporation, an Allergan affiliate. Grafton® DBM is a registered trademark of Medtronic, Inc. Cytoplast® is a registered trademark of Osteogenics Biomedical, Inc. Puros Dermis is a registered trademark of Zimmer Biomet. Mucograft is a registered trademark of Ed. Geistlich Sogne Ag Fur Chemische Industrie. Symbios PerioDerm is a registered trademark of Dentsply Sirona. Hu-Friedy® is a registered trademark of Hu-Friedy Mfg. Co., LLC. Spiralock® is a registered trademark of Spiralock Corporation. Pomalux® is a registered trademark of Westlake Plastics Co. Locator® is a registered trademark of Zest Anchors, Inc. Delrin® is a registered trademark of E.I. du Pont de Nemours and Company. Bio-Gide® is a registered trademark of Edward Geistlich Sohne AG Fur Chemische Industrie. BioMend® is a registered trademark of Zimmer Biomet Dental. IntraSpin®, L-PRF® and Xpression® are trademarks of Intra-Lock® International Inc. Not all products shown or described in this literature are available in all countries. As applicable, BioHorizons products are cleared for sale in the European Union under the EU Medical Device Directive 93/42/EEC and the tissues and cells Directive 2004/23/EC. We are proud to be registered to ISO 13485:2016, the international quality management system standard for medical devices, which supports and maintains our product licences with Health Canada and in other markets around the globe. Original language is English. ©BioHorizons. All Rights Reserved.



L02024



REV G MAR 2020

shop online at  
**store.biohorizons.com**